



شركة المتكاملة لصناعة الحجر البيئي  
Integrated Eco Stone Company



## • الحجر البيئي

الحجر البيئي هو حجر مصنع من خلطة خرسانية ذات مواصفات عالية ، ونسبة ملروسة من البصريات ذات قساوة عالية جداً ، ويمل زجاجي مضافاً إلى هذه التركيبة مواد كيميائية خاصة ومعالجة فيزيائياً حيث يتم رفع أداء الرابطة الإسمنتية بينها للوصول إلى قساوة عالية جداً. وقد استعمل الحجر البيئي بشكل واسع في الكثير من المباني المتقوية محلياً في الأردن وخارجياً مثل المملكة العربية السعودية، الإمارات العربية المتحدة، سوريا، روسيا، رومانيا، وكازاخستان، أمريكا. ويمتاز الحجر البيئي بالمواصفات التالية :

- بما أن الرابطة الأساسي هو الإسمنت فهو مادة مجرية منذ مئات السنين ولا يتأثر بالعوامل الجوية وعمره غير محدود وألوانه ثابتة لا تتغير مع الزمن وقد ثبت ذلك .
- الحجر البيئي يعتبر مادة مثالية لعزل الواجهات الخارجية عن الماء ومنع دخول الرطوبة للمبنى .
- الحجر البيئي يمكن تصنيحه بأشكال ومقاسات وألوان متعددة ويمكن كذلك تصنيحه حسب الطلب .
- لاستعمال الحجر البيئي يمكن توحيد وإنتظام النقشة للواجهات بحيث يعطي نسبة توحيد 100% للون والنقشة .
- يعتبر الحجر البيئي مادة يكون ممتازة ومثالية حيث تحقق جمالية المظهر مع إنخفاض السعر مقارنة مع الحجر الطبيعي .
- إمكانية الفرز والشطف وبعض الزخارف للحجر البيئي دون علاوات في السعر .
- يلتصق الحجر البيئي مع مونة التركيب بشكل قوي جداً كون سطحه الخلفي خشن مع إمكانية حمل دسر ميكانيكية للصالات الخاصة .

### ضمن فعاليات برنامج إرادته

الذي تموله وزارة التخطيط وتديره الجمعية العلمية الملكية

فازت الشركة المتكاملة لصناعة الحجر البيئي

بجائزة المشروع المتميز عن محافظة الزرقاء لعام ٢٠١٧

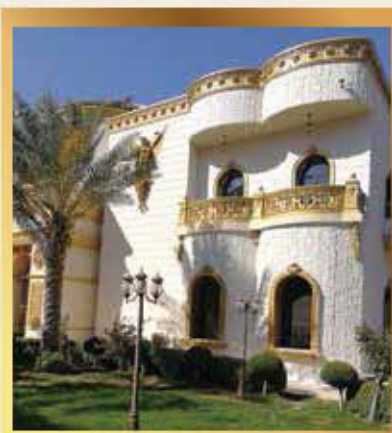
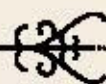
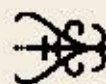
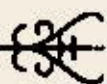
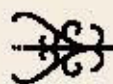

نماذج من المباني التي بنيت من الحجر البيئي في الأردن

No : 24

رملی ساده



جميع المقاسات

No : 19

فرزتين زاوية

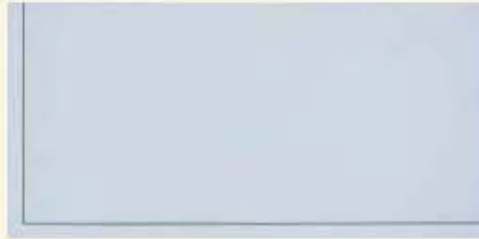

( 25 x 50 ) ( 40 x 40 ) ( 50 x 50 )

No : 2

أملس ساده



جميع المقاسات

No : 26

رملی فرزہ



( 25 x 60 ) ( 30 x 60 ) ( 50 x 70 )

No : 10

مشطوف اربع جهات



( 25 x 25 ) ( 30 x 30 )

No : 4

أملس فرزہ



( 30 x 60 ) ( 40 x 70 ) ( 50 x 70 )

No : 28

رملی فرزہ زاوية



( 25 x 50 ) ( 40 x 40 ) ( 50 x 50 )

No : 11

مشطوف اربع جهات



( 25 x 50 ) ( 30 x 60 )

No : 8

أملس شطفتين

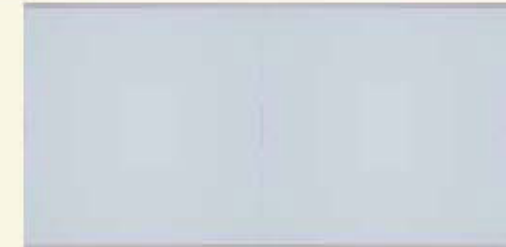

( 20 x 40 ) ( 25 x 50 ) ( 30 x 60 )

No : 42

خشن سادة



جميع المقاسات

No : 41

عجمي سادة



جميع المقاسات

No : 23

مطبه سادة



جميع المقاسات

No : 44

خشن فرزه



( 30 x 60 ) ( 50 x 70 )

No : 43

عجمي فرزه



( 30 x 60 ) ( 50 x 70 )

No : 25

مطبه فرزه



( 30 x 60 ) ( 50 x 70 )

No : 48

خشن شطفتين



( 30 x 60 )

No : 47

عجمي شطفتين



( 25 x 50 ) ( 30 x 60 )

No : 29

مطبه شطفتين



( 25 x 50 ) ( 30 x 60 )

No : 55

مفجر



( 25 x 50 ) ( 30 x 60 ) ( 50 x 70 )

No : 100

سليت



( 15 x 60 ) ( 30 x 60 )

No : 101



( 20 x 50 )

No : 124

طبزه مقطع



( 30 x 60 )

No : 102



( 30 x 43 )

No : 103



( 32 x 45 )

No : 140

طبزه



مقاسات متنوعة

No : 104



( 27 x 40 )

No : 106



( 28 x 53 )

No : 118



(31 × 57)

No : 110



(50 × 50)

No : 119



(60 × 60)

No : 111



مقاسات متنوعة

No : 112



(27 × 50)

No : 113



(27 × 47)

No : 105



مقاسات متنوعة

No : 114



(27 × 47)

No : 115



(26 × 47)

**No : 200**

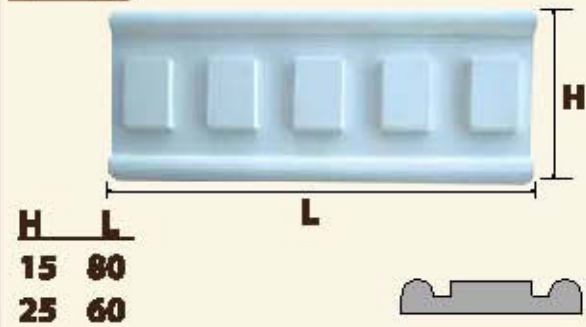

**No : 217**



**( 25 × 60 )**

**No : 246**



**( 15 × 100 )**

**No : 209**



**( 20 × 60 )**

**No : 231**



**( 27 × 60 )**

**No : 261**



**( 30 × 80 )**

**No : 212**

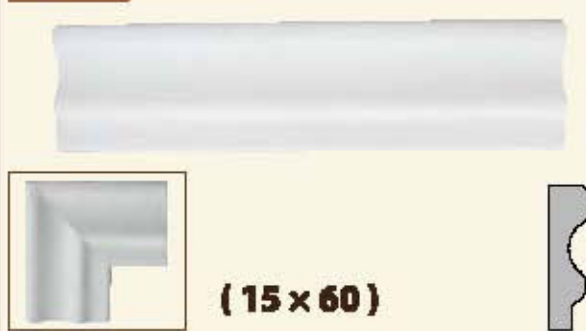

**( 15 × 60 )**

**No : 221**



**( 10 × 60 )**

**No : 220**



**( 30 × 60 )**

**No : 208**



**( 5 × 95 )**

**No : 222**



**( 9 × 60 )**

**No : 207**



L  
H L  
10 60  
20 100



**No : 206**



**( 7 × 60 )**



**No : 218**



**( 24 × 60 )**

**No : 211**



**( 16 × 60 )**  
**( 20 × 60 )**  
**( 25 × 60 )**



**No : 210**



**( 30 × 60 )**



**No : 219**



**( 17 × 60 )**

**No : 214**



**( 15 × 62 )**

**No : 213**



**( 18.5 × 62 )**



**No : 226**



**( 25 x 60 )**

**No : 228**



**( 22 x 60 )**

**No : 229**



**( 30 x 73 )**

**No : 232**



**( 30 x 60 )**

**No : 230**



**( 30 x 77 )**

**No : 235**



**( 28 x 50 )**

**No : 245**



**( 31 x 60 )**



No : 290



(45 x 120)

No : 256



(25 x 100) (25 x 115)

No : 259



(35 x 90 x 16)

No : 263



(30 x 100) (20 x 125)

No : 288



(25 x 100)

No : 252



(30 x 100)

No : 289



(25 x 100)

No : 267



(25 x 100) (25 x 115)



No : 268



No : 266

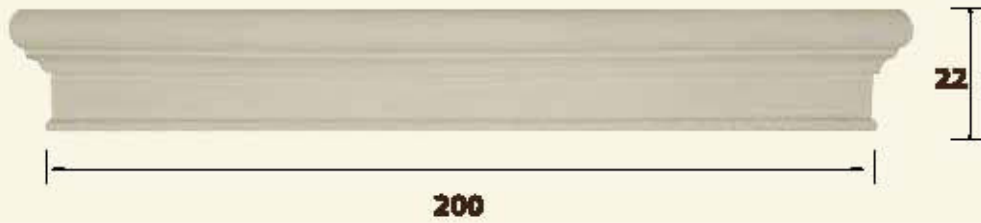

No : 267



No : 269



No : 270



No : 275



No : 281

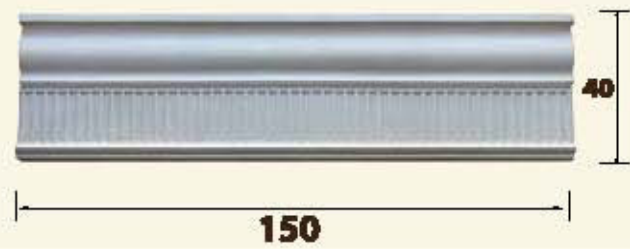

No : 290

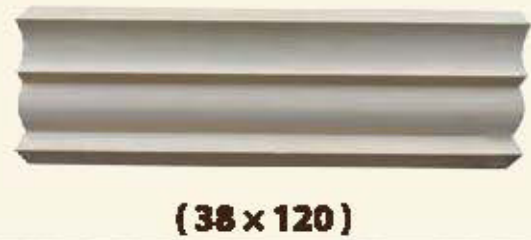

No : 283

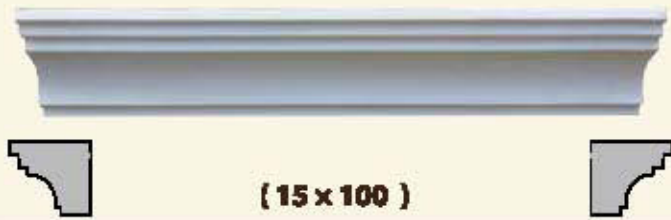

(15 x 100)

No : 280



(40 x 100)

No : 284

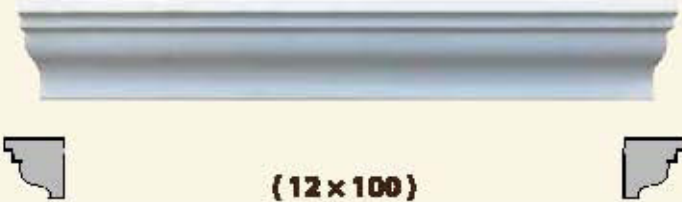

(12 x 100)

No : 281



(30 x 100)

No : 286



(9 x 100)

No : 285



(10 x 100)

No : 287



(10 x 100)

No : 282



(15 x 100)

Arc : 20

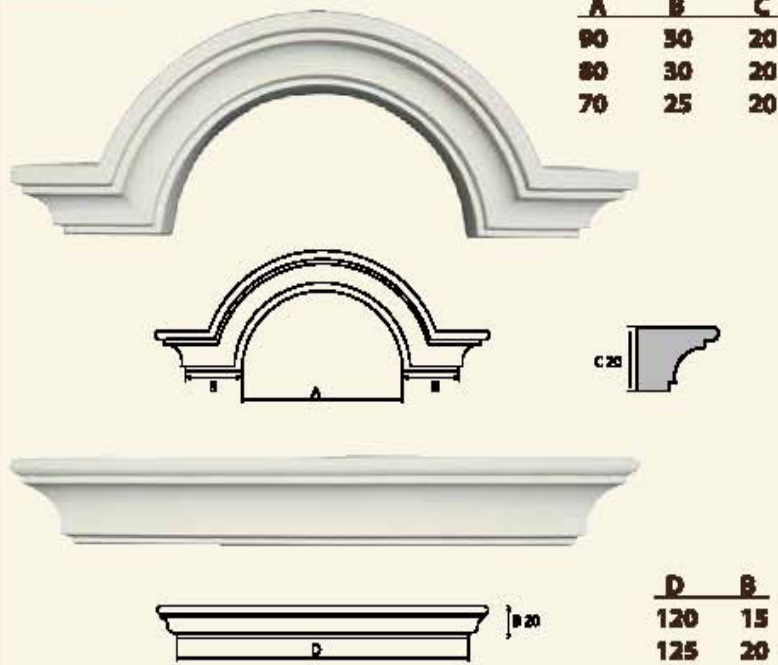

Arc : 40



Arc : 41



Arc : 35



Gr : 2



Gr : 1



Gr : 3



Gr : 4



Arc : 22

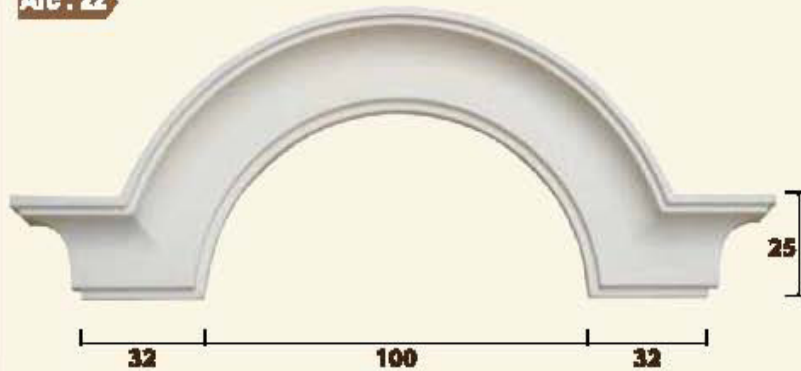

Arc : 30



Gr : 5



Gr : 6



Arc: 11



Arc: 12



Arc: 13



Arc: 14



Arc : 10

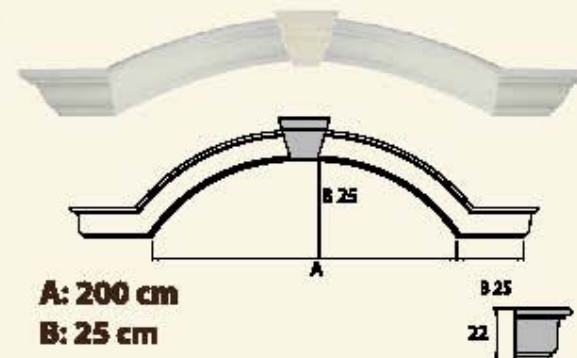

Arc : 25

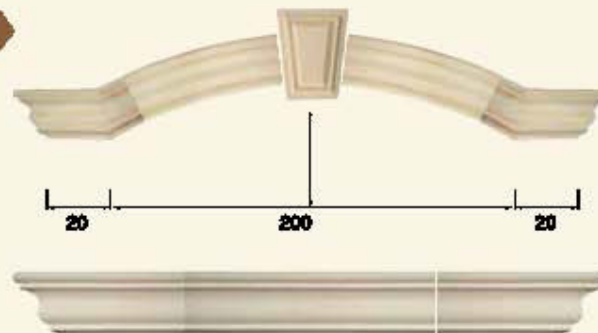

Arc : 31



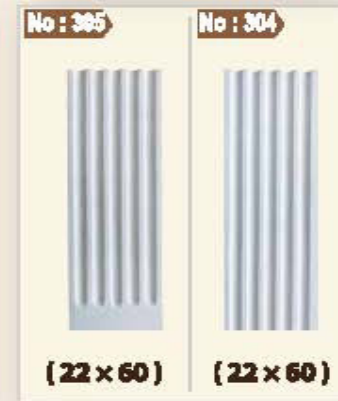
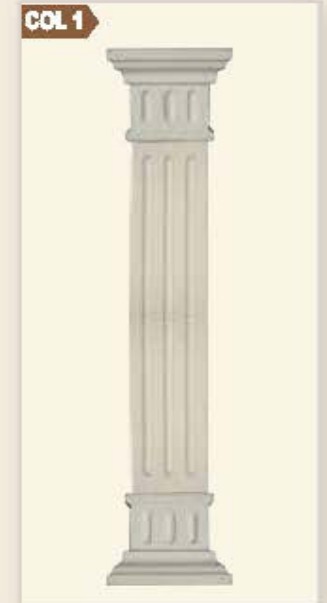
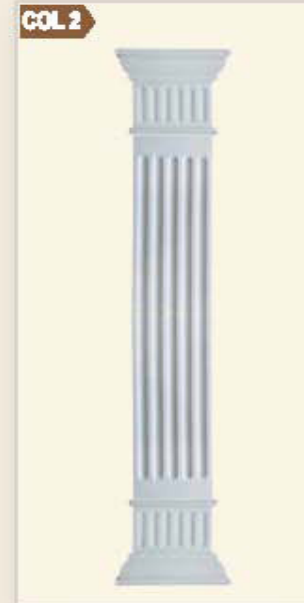
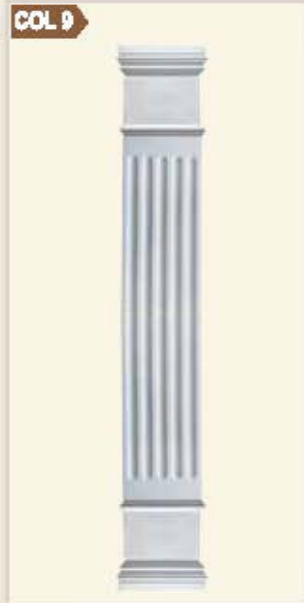

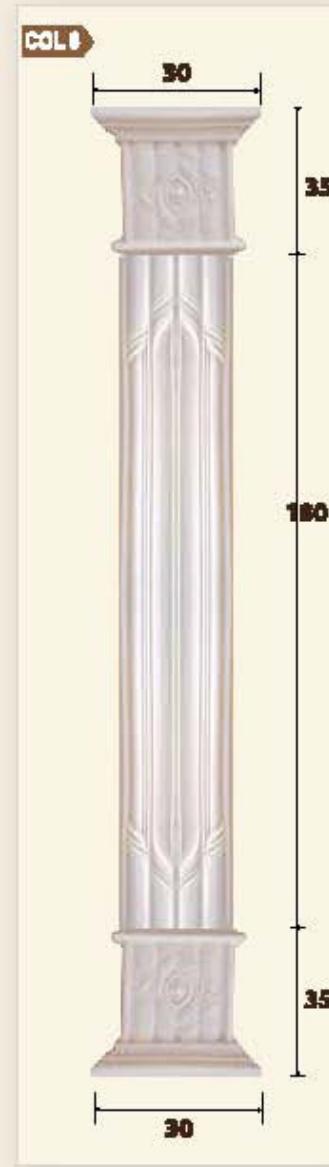
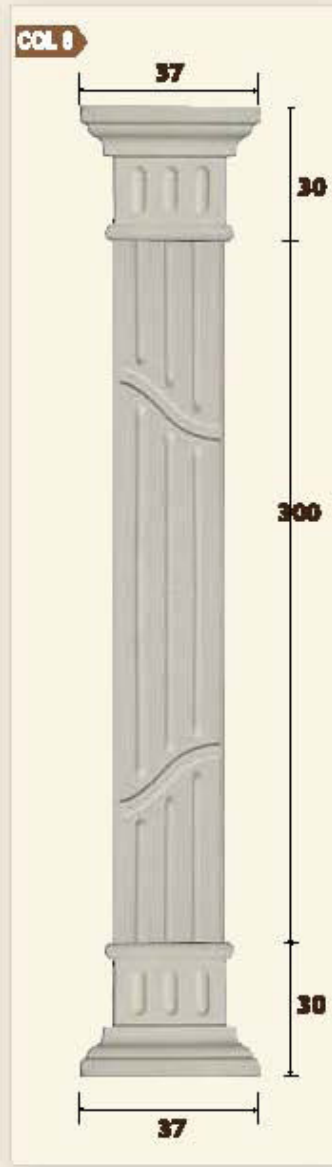



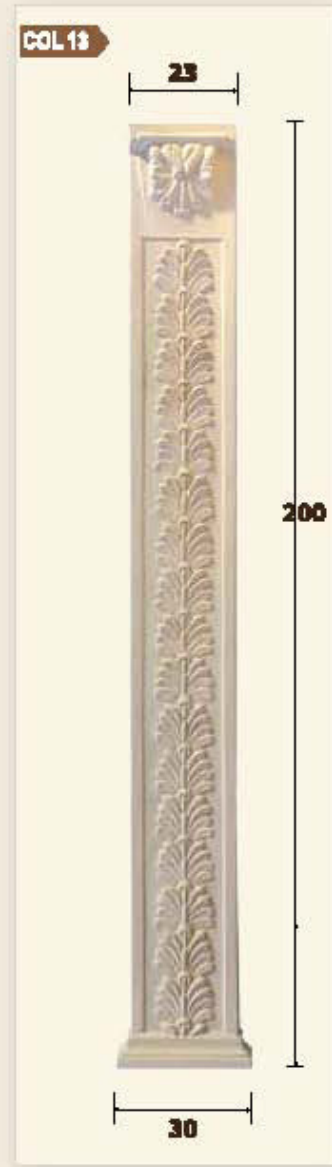
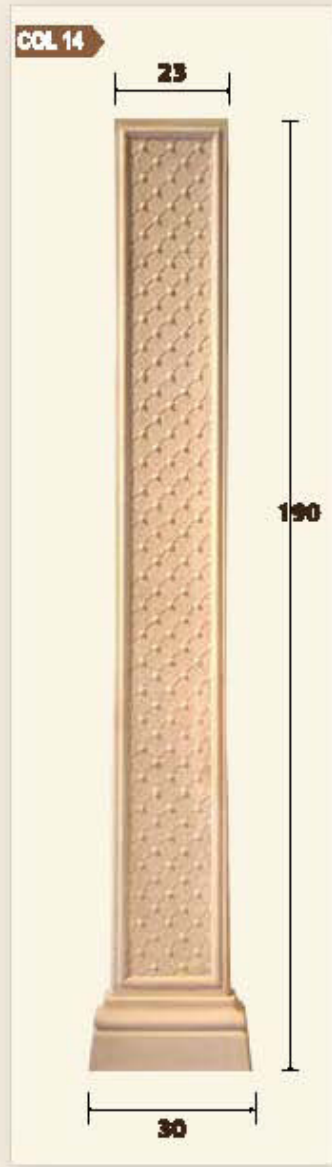
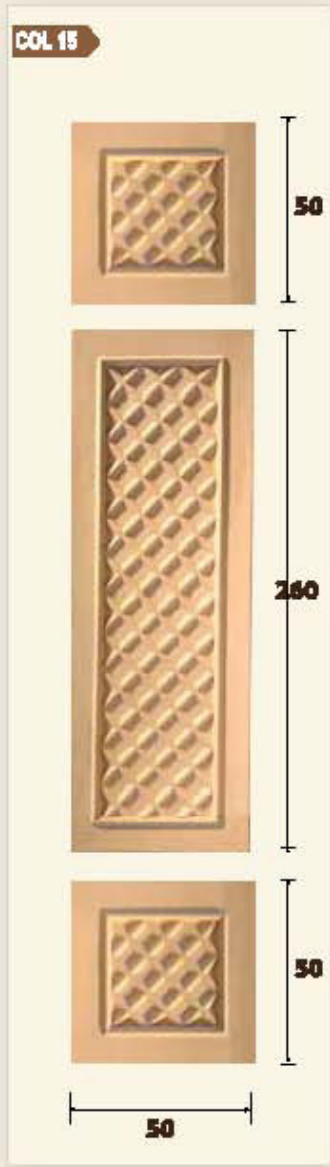

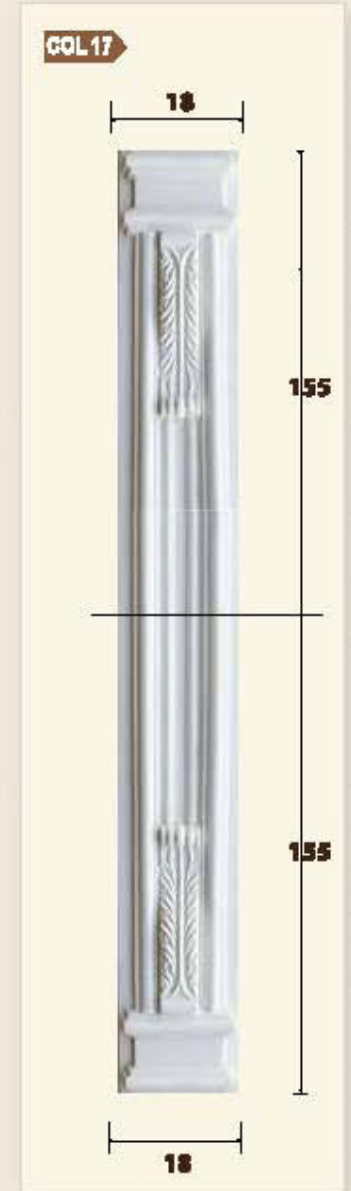
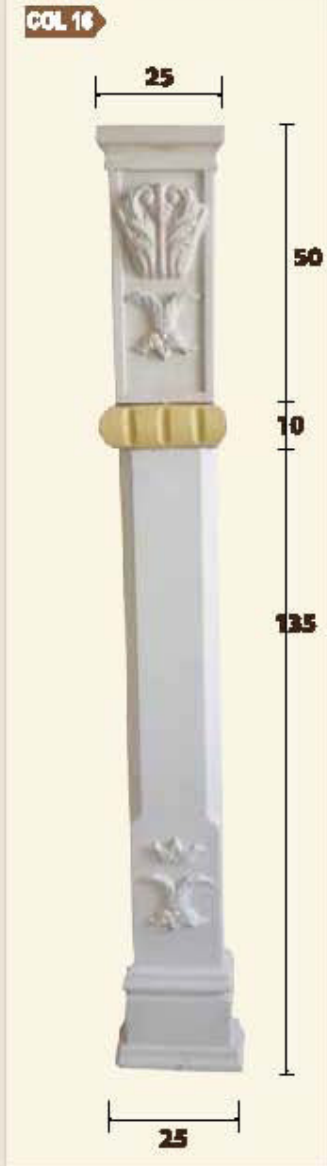

Fin 11



(145 x 52)

Fin 10



(130 x 52)

Fin 11 e



(145 x 52)

Fin 10 e



(130 x 52)

Fin 18



(87 x 87)

Fin 14



(75 x 75)

Fin 13



(38 x 70)

Fin 12



(57 x 90)



# DECOR STONE

## Decoration

## الديكورات

TD : 47



( 30 × 30 )

TD : 48



( 30 × 30 )

TD : 49



( 60 × 60 )

TD : 50



( 60 × 60 )

TD : 51



( 30 × 30 )

TD : 52



( 50 × 50 )

TD : 53



( 60 × 60 )

TD : 54



( 60 × 60 )

TD : 55

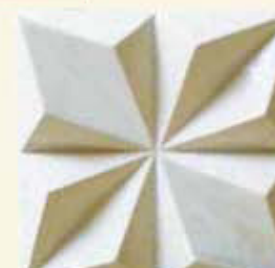

( 30 × 30 )

# Decoration

# الديكورات

TD : 10



( 30 x 30 )

TD : 11



( 25 x 25 )

TD : 12



( 30 x 30 )

TD : 14



( 20 x 20 )

TD : 15



( 30 x 30 )

TD : 16



( 30 x 30 )

TD : 17



( 30 x 30 )

TD : 18



( 30 x 30 )

TD : 19



( 20 x 20 )



# DECOR STONE

## Decoration

## الديكورات

TD : 20



( 20 × 20 )

TD : 21



( 20 × 20 )

TD : 22



( 20 × 20 )

TD : 23



( 20 × 20 )

TD : 24



( 20 × 20 )

TD : 25



( 20 × 20 )

TD : 26



( 20 × 20 )

TD : 27



( 30 × 30 )

TD : 28



( 20 × 20 )



TD : 29



( 25x 25 )

TD : 30



( 30x 30 )

TD : 31



( 35x 35 )

TD : 32



( 30x 30 )

TD : 33



( 30x 30 )

TD : 34

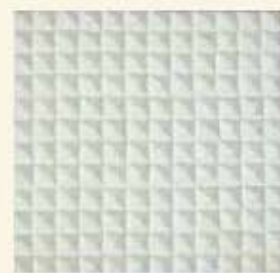

( 30x 30 )

TD : 35



( 30x 30 )

TD : 36



( 30x 30 )

TD : 37



( 30x 30 )





NO :125



( 30 × 56 )

NO :120



( 30 × 60 )

NO :129



( 30 × 60 )

NO :126



( 15 × 45 )

NO :135



( 30 × 60 )

NO :136



( 30 × 60 )







NO :137



( 50 × 100 )

NO :140



( 15 × 45 )

NO :138



( 50 × 100 )

NO :141



( 33 × 66 )

NO :139



( 50 × 100 )

NO :142



( 15 × 45 )



# DECOR STONE

## Decoration

## الديكورات

NO :132



( 25 x 50 )

NO : 127



( 15 x 30 )

NO : 130



( 30 x 45 )

NO :133



( 31 x 56 )

NO : 123



( 20 x 20 )

TD : 13



( 30 x 30 )

TD : 42



( 30 x 30 )

TD:43



(30 x 30)

TD:39



(25 x 25)

TD:41



(50 x 50)

FD 5



(30 x 50)

TD:56



(30 x 30)

TD:60



(30 x 30)

FD 8



(25 x 45)

No: 233



(45 x 45)

TD:44



(40 x 40)

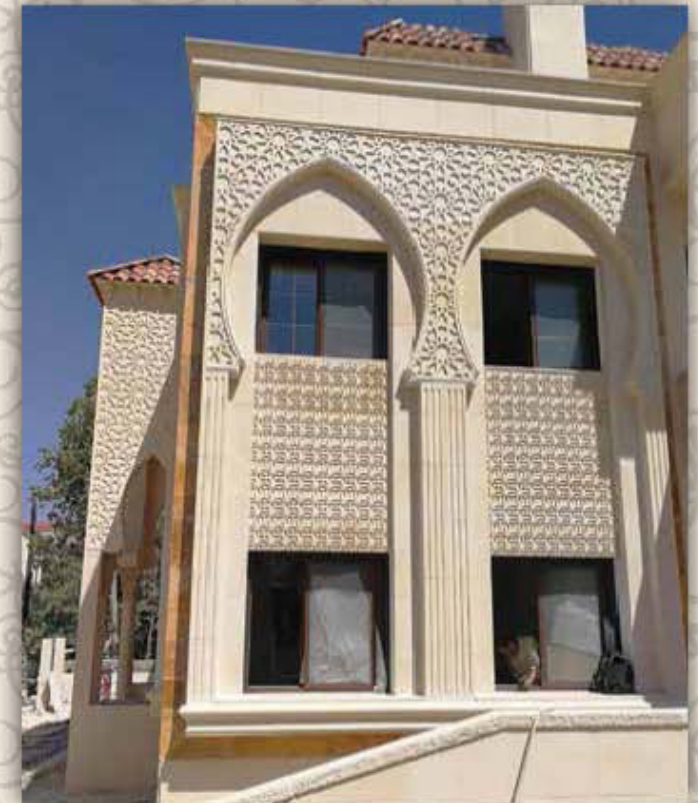



## Dec. Portraits

## لوحات ديكورية

PD : 01



( 40 × 80 )

PD : 02

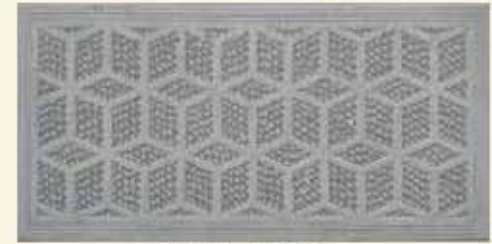

( 40 × 80 )

PD : 03



( 40 × 80 )

PD : 04



( 40 × 80 )

PD : 05



( 40 × 80 )

PD : 06



( 40 × 80 )

Dec. Portraits

لوحات ديكورية

TD : 40



( 40 x 40 )

PD : 7



( 45 x 45 )

TD : 38



( 40 x 40 )

FD 1



( 50 x 100 )

PD : 08



( 60 x 80 )

FD 2



( 50 x 100 )

**DECOR  
STONE**





PD : 09



( 55 x 182 )

PD : 10



( 55 x 182 )

PD : 11



( 60 x 220 )

PD : 15



( 60 x 60 )

PD : 12



( 60 x 112 )

PD : 13



( 60 x 90 )

PD : 14



( 54 x 80 )



### • أسماء بعض المشاريع المستخدمة لمنتجاتنا

فيلا الدكتور طارق رزقية / هفا بدران	شركة الارشاد للمشاريع الاسكانية / الجبیهه	فيلا السيد رالف الريحاني / العمر	مبنى مسجد المزينة / الخبر - السعودية
فيلا المهندس هشام شعبان / هفا بدران	شركة الضحل والنديش للاسكان / ام اذنية	فيلا السيد أحمد السويلمي / هفا بدران	مبنى بلدية العزينة / الخبر - السعودية
فيلا المهندس فواد قاعود / الرمان	شركة بنايتي للمشاريع الاسكانية / الكرسي	فيلا الدكتور م. محمد الرجوب / مويص	مبنى بلدية الثقبة / الخبر - السعودية
فيلا المهندس زياد المدوان / السلط	فيلا السيد محمد حسين / الكمالية	شركة الزر والداود للاسكان / هيدون	كلية الاميرة سمية - مبنى النشاطات
فيلا المهندس هسان فارس / زي	شركة بالوس هايتمس للاسكان / عين غزال	منزل الدكتور خميس عاشور / خلدا	فندق ومجمع الرهاد السياحي / الجبیهه
فيلا السيد نارت كوف / مرج الحمام	شركة المهندس للمشاريع الاسكانية / الجبیهه	شركة ارتفين للاسكان / دير غبار	فيلا المهندس نادر هلسة / موسكو - روسيا
منزل السيد عبد الكريم الخطيب / البيضاء	شركة البيارق للاسكان / ضاحية الرشيد	مصنع التراهدين للورق الصحي / ماركا	فيلا المهندس هتحي الطاهر / رومانيا
فيلا السيد سالم اللوزي - الجبیهه	فيلا السيد سمود الفضلي / الكمالية	فندق القدس / المدينة الرياضية	شركة مجمع تاكي التجاري / التميماني
فيلا السيد عواد عكاش / مرج الحمام	فيلا المهندس عماد نجيب الهاور / البنيات	شركة حجر الزاوية للاسكان / ماديا	مجموعة الامعري للاستثمار / دير غبار - اريد
فيلا السيد صلاح الصافي / السلط	فيلا السيد صدنان عيد / الكمالية	شركة اليازي للاسكان / جبل الحصين	فيلا السيد كمال الزقوف / هيدون
فيلا المهندس سليم دحبور / هفا بدران	منزل رياض الصيوف / الهاشمي الشمالي	مصنع بوخته ايزبيرغ / ماركا الشمالية	مطعم سراي / هيدون
فيلا المهندس شادي التخليبي / مرج الحمام	شركة نور للاسكان / الكماليه	مجمع المهندس غالب ابو عرابي / عين البها	شركة الموصلني للاسكان / هيدون
			فيلا الدكتور م. اسمايل عقيل / الكمالية

- وغيرها من المشاريع في عمان والزرقاء والطفيلة والسلط وايد

# DECOR STONE

افاق واسعة

في تلبية جميع متطلبات مهندسي البناء  
والديكور الداخلي والخارجي

طموحاتنا غير محدودة

في التطوير والتحسين  
وانتاج أفضل أنواع الحجر والتصاميم

Tel : +962 6 5344566 Fax : +962 6 5350888 P.O.Box 2412 Amman 11941 Jordan e-mail : info@theeco-stone.com

www.theeco-stone.com